

Product Sheet ZZ14-770

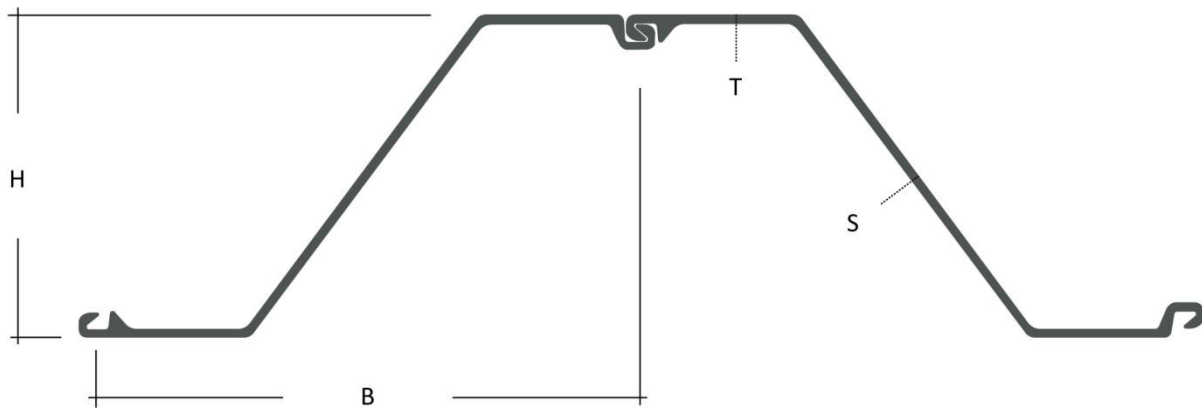

Single Pile				Per m of wall				
Width	Height	Thickness		Weight	Weight	Cross Sectional Area	Moment of Inertia	Section Modulus
SB	H	T	S	G	M	A	I _y	W _y
mm	mm	mm	mm	kg/m	kg/m ²	cm ² /m	cm ⁴ /m	cm ³ /m
770	344.5	9.6	9.5	103.4	79.6	1018	2337	1357